

Article number: 3901210010200

Description: Worm gear with solid input shaft
VF 210A-10-HS

Measures

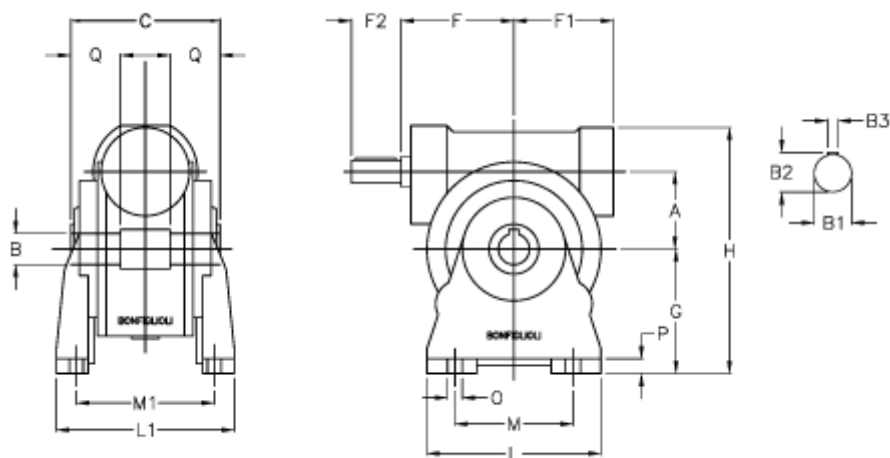

a	= 210.0	F1	= 277	P	= 25
B	= 90	g	= 335	Q	= 85.0
B1 E7	= 48	H	= 665		
B2	= 51.5	L	= 440		
B3 H9	= 14	L1	= 320		
C	= 260	m	= 340		
Description	= VF 210A-xx-HS	M1	= 265.0		
F	= 230.0	O	= 26.0		